

HERITAGE® ARCHITECTURAL ASPHALT SHINGLES

DALLAS, TX • FREDERICK, MD • JOPLIN, MO • PHILLIPSBURG, KS • TUSCALOOSA, AL



SHINGLES BEGIN TO AGE AS SOON AS THEY ARE EXPOSED TO NATURE. BUILDINGS EXPERIENCE AGING FACTORS DIFFERENTLY, SO IT IS DIFFICULT TO PREDICT HOW LONG SHINGLES WILL LAST. TAMKO PROVIDES A LIMITED WARRANTY FOR MANY PRODUCTS, THAT INCLUDES A BINDING ARBITRATION CLAUSE AND OTHER TERMS AND CONDITIONS WHICH ARE INCORPORATED HEREIN BY REFERENCE. YOU MAY OBTAIN A COPY OF THE LIMITED WARRANTY AT TAMKO.COM OR BY CALLING 1-800-641-4691.

WARNING: Use of this product in an assembly that includes polyurethane foam insulation (including without limitation an application directly to the underside of a roof deck or within a wall assembly) may cause premature degradation or failure of this product. Chemical incompatibility, off-gassing after application and excess heat during and after application of polyurethane foams may affect the performance of asphalt and modified asphalt building products and metal fasteners used with those products.



IMPORTANT SAFETY INFORMATION: Do not install until all appropriate safety precautions have been read and understood. The TAMKO Safety Data Sheet (SDS) is available at tamko.com/sds. Always use appropriate fall protection equipment and wear appropriate personal protective equipment (PPE) when working with this product. Moisture, frost, debris or other material will decrease the traction and can cause slippery conditions when walking on the product. **Applicator safety is of utmost importance.**

THESE ARE THE MANUFACTURER'S APPLICATION INSTRUCTIONS FOR ROOFING CONDITIONS DESCRIBED. TAMKO BUILDING PRODUCTS LLC ASSUMES NO RESPONSIBILITY FOR LEAKS OR OTHER DEFECTS RESULTING FROM FAILURE TO FOLLOW THE MANUFACTURER'S INSTRUCTIONS. FAILURE TO FOLLOW THESE INSTRUCTIONS WILL ADVERSELY AFFECT COVERAGE UNDER THE LIMITED WARRANTY AND ARBITRATION AGREEMENT. SEE THE LIMITED WARRANTY FOR DETAILS.

CHECK LOCAL BUILDING CODES TO DETERMINE SUITABILITY OF THIS PRODUCT FOR YOUR INTENDED USE.

INFORMATION INCLUDED IN THESE APPLICATION INSTRUCTIONS WAS CURRENT AT THE TIME OF PRINTING. TO OBTAIN A COPY OF THE MOST CURRENT VERSION OF THESE APPLICATION INSTRUCTIONS, VISIT US ONLINE AT WWW.TAMKO.COM OR CALL US AT 1-800-641-4691.

THIS TAMKO® PRODUCT IS COVERED BY A LIMITED WARRANTY AND ARBITRATION AGREEMENT, THE TERMS OF WHICH ARE PRINTED ON THE WRAPPER.

IN COLD WEATHER (BELOW 40°F), CARE MUST BE TAKEN TO AVOID DAMAGE TO THE EDGES AND CORNERS OF THE SHINGLES.

IT IS NOT NECESSARY TO REMOVE THE PLASTIC STRIP FROM THE SHINGLES.

IMPORTANT INFORMATION FOR SHINGLES MANUFACTURED IN TUSCALOOSA, AL:

THE FASTENING PATTERNS DIFFER FOR SHINGLES MANUFACTURED ON LINE 1 VERSUS LINE 2. LOOK FOR PRODUCTION INFORMATION PRINTED ON THE SIDES OR TOP OF EACH BUNDLE.

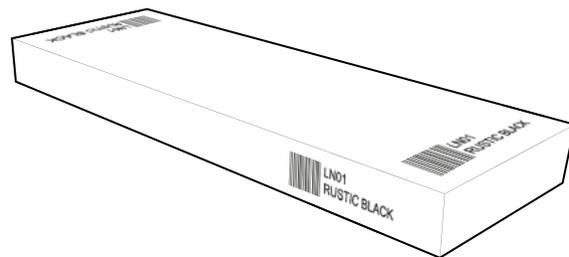

HERITAGE® ARCHITECTURAL ASPHALT SHINGLES

DALLAS, TX • FREDERICK, MD • JOPLIN, MO • PHILLIPSBURG, KS • TUSCALOOSA, AL



I. ROOF DECK

These shingles are for application to roof decks consisting of plywood, oriented strand board (OSB) or sheathing boards capable of receiving and retaining fasteners, and to inclines of not less than 2" per foot.

Shingles must be applied in strict accordance with the application instructions. TAMKO assumes no responsibility for leaks or defects resulting from improper application, or failure to properly prepare the surface to be roofed over.

STANDARD ROOF: For roofs having slopes equal to or greater than 4" per foot and up to but less than 21" per foot (4:12 and up to but less than 21:12).

LOW-SLOPE: For roofs having slopes 2" per foot up to but less than 4" per foot (2:12 up to but less than 4:12), refer to special instructions titled "Low Slope Application."

MANSARD ROOF OR STEEP SLOPE: For roofs having slopes equal to or greater than 21" per foot, refer to special instructions titled "Mansard Roof or Steep Slope Roof."

NEW ROOF DECK CONSTRUCTION: Roof deck must be smooth, dry and free from warped surfaces. It is recommended that metal drip edges be installed at eaves and rakes.

PLYWOOD: All plywood shall be exterior grade as defined by APA - The Engineered Wood Association. Plywood shall be a minimum of 3/8" thickness and applied in accordance with the recommendations of APA - The Engineered Wood Association.

ORIENTED STRAND BOARD: Oriented strand board shall be exterior grade as defined by APA - The Engineered Wood Association, minimum 7/16" thickness, APA-rated in accordance with Voluntary Standard PS 2 and applied in accordance with the recommendations of APA - The Engineered Wood Association.

SHEATHING BOARDS: Boards shall be well-seasoned tongue-and-groove boards and not over 6" nominal width. Boards shall be a 1" nominal minimum thickness. Boards shall be properly spaced and nailed.

2. VENTILATION

Inadequate ventilation of attic spaces can cause accumulation of moisture in winter months and a build-up of heat in the summer. These conditions can lead to:

1. Vapor condensation.
2. Buckling of shingles due to deck movement.
3. Rotting of wood components.
4. Premature failure of roof.

To ensure adequate ventilation and circulation of air, the ventilation system must include inlets and outlets. This may be accomplished with a combination of ridge and soffit vents or by using gable end vents. FHA minimum property standards require one square foot of net free ventilation area to each 150 square feet of space to be vented.

This may be reduced to one square foot of ventilation area per 300 square feet if at least 40% and not more than 50% of venting is provided not more than 3 feet below the ridge and if a Class I or II vapor barrier is installed on the warm-in-winter side of the ceiling in climate zones 6, 7, and 8 as recommended by the 2021 International Residential Code. For more information consult your design professional. If the ventilation openings are screened, the total area should be doubled.

IT IS PARTICULARLY IMPORTANT TO PROVIDE ADEQUATE VENTILATION.

3. FASTENERS

NAILS: TAMKO requires the use of nails as the method of application. Standard type roofing nails should be used. Nail shanks should be made of minimum 12 gauge wire, and a minimum head diameter of 3/8". Nails should be long enough to penetrate 3/4" into the roof deck. Where the deck is less than 3/4" thick, the nails should be long enough to penetrate completely through decking and extend at least 1/8" through the roof deck. Drive nail head flush with the shingle surface.

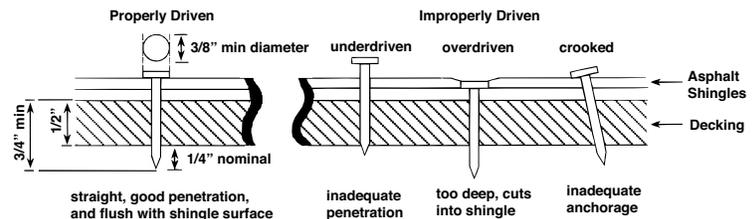

WIND CAUTION: Extreme wind velocities can damage these shingles after application when proper sealing of the shingles does not occur. This can especially be a problem if the shingles are applied in cooler months or in areas on the roof that do not receive direct sunlight. These conditions may impede the sealing of the adhesive strips on the shingles. The inability to seal down may be compounded by prolonged cold weather conditions and/or blowing dust. In these situations, hand sealing of the shingles is required. To ensure quicker sealing, apply 4 quarter-sized dabs of any adhesive meeting ASTM D4586, Type I, on the back of the shingle 1" and 13" in from each side and 1" up from the bottom of the shingle. Press shingle firmly into the adhesive. For maximum wind resistance along rakes, install any TAMKO starter shingle including sealant or cement shingles to the underlayment and each other in a 4" width of any adhesive meeting ASTM D4586, Type I. Caution: Apply ONLY a thin uniform layer of adhesive less than 1/8" thick. Excessive amounts can cause blistering of the shingles and may soften the asphalt in certain underlayments resulting in the asphalt flowing, dripping and staining. Shingles must also be fastened according to the fastening instructions described below.

3. FASTENERS (continued)

Correct placement of the fasteners is critical to the performance of the shingle. **If the fasteners are not placed as shown in the diagram as described below, this will result in the termination of TAMKO's liabilities under the Limited Warranty and Arbitration Agreement.**

TAMKO will not be responsible for damage to shingles caused by winds in excess of the applicable MPH as stated in the Limited Warranty and Arbitration Agreement. See Limited Warranty and Arbitration Agreement on the wrapper or tamko.com for details.

1) STANDARD FASTENING PATTERN:

For use on decks with slopes 2" per foot up to but less than 21" per foot.

One fastener 1" from each end and one fastener 13-1/2" from each end for a total of 4 fasteners per shingle. (See Standard Fastening Pattern illustrated below.)

STANDARD FASTENING PATTERN

ALL LOCATIONS EXCEPT LINE 2 TUSCALOOSA, AL

FASTENERS MUST BE PLACED 6-1/8" FROM THE BOTTOM EDGE OF THE SHINGLE, PENETRATING THROUGH THE COMMON BOND, AND LOCATED HORIZONTALLY AS FOLLOWS:

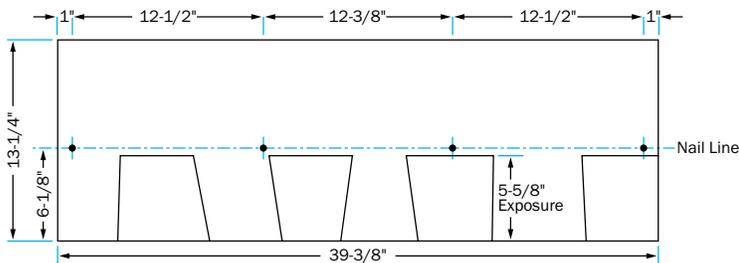

ONLY FOR LINE 2 TUSCALOOSA, AL

FASTENERS MUST BE PLACED 7-1/4" FROM THE BOTTOM EDGE OF THE SHINGLE AND LOCATED HORIZONTALLY AS FOLLOWS:

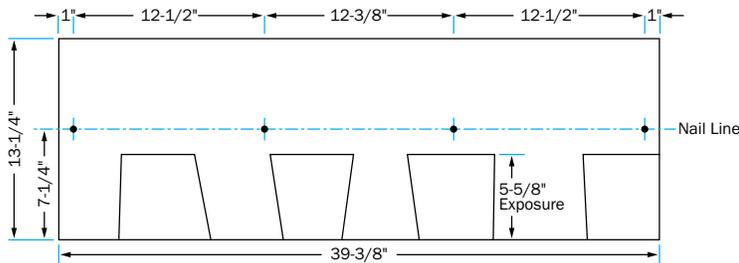

FOR ALL LOCATIONS AND LINES

2) MANSARD ROOF OR STEEP SLOPE FASTENING PATTERN:

For use on decks with slopes equal to or greater than 21" per foot.

One fastener 1" from each end, one fastener 8-1/2" from each end and one fastener 16" from each end for a total of 6 fasteners per shingle. (See High Wind Warranty, Mansard Roof or Steep Slope Fastening Pattern illustrated below.)

3) HIGH WIND WARRANTY FASTENING PATTERN:

One fastener 1" from each end, one fastener 8-1/2" from each end and one fastener 16" from each end for a total of 6 fasteners per shingle. (See High Wind Warranty, Mansard Roof or Steep Slope Fastening Pattern illustrated below.)

CAUTION: ALL FASTENERS FOR MANSARD AND HIGH WIND APPLICATIONS MUST BE DRIVEN INTO THE COMMON BOND AS SHOWN IN THE HIGH WIND WARRANTY, MANSARD ROOF OR STEEP SLOPE FASTENING PATTERN DIAGRAM BELOW.

HIGH WIND WARRANTY, MANSARD ROOF OR STEEP SLOPE FASTENING PATTERN

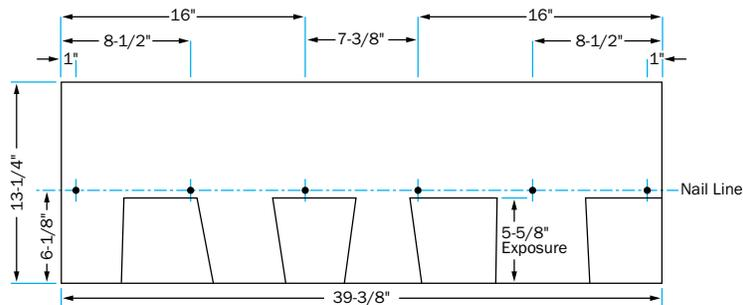

4) ADDITIONAL REQUIREMENTS FOR HIGH WIND WARRANTY:

TAMKO also requires the use of TAMKO® starter shingles including sealant strip at eaves and rakes. Alternatively, along rakes, cement shingles to the underlayment and each other in a 4" width of any adhesive meeting ASTM D4586, Type I. Caution: Apply ONLY a thin uniform layer of adhesive less than 1/8" thick. Excessive amounts can cause blistering of the shingles and may soften the asphalt in certain underlayments resulting in the asphalt flowing, dripping and staining.

High Wind Application is offered on new construction or complete tear-off applications only. It is not offered for re-cover applications. If High Wind Application requirements are not followed, the High Wind Application Warranty MPH, as stated on Table I in the Limited Warranty and Arbitration Agreement, reverts to the Standard Application Wind Warranty MPH limit. (See High Wind Warranty, Mansard Roof or Steep Slope Fastening Pattern illustrated above.)

"High Wind Application" means application of shingles in strict accordance with the High Wind Warranty Fastening Pattern application instructions stated previously. See local building codes for additional nailing requirements.

4. UNDERLAYMENT

UNDERLAYMENT: An underlayment must be applied over the entire deck before the installation of TAMKO® shingles. Failure to add underlayment can cause premature failure of the shingles, which is not covered by TAMKO's Limited Warranty and Arbitration Agreement.

Products which are acceptable for use as underlayment are:

Asphalt Saturated Felt Underlayments

- Any TAMKO® non-perforated asphalt saturated organic felt
- A non-perforated asphalt saturated organic felt which meets ASTM D226 or ASTM D4869

Specialty Underlayments

- Synthetic Guard™ Plus Underlayment or Synthetic Guard™ Underlayment
- A polymeric underlayment designed for use with asphalt shingles which meets ASTM D8257
- TAMKO® Moisture Guard® Ice & Rain Underlayment, TW Underlayment or TW Metal and Tile Underlayment (additional ventilation may be required—contact TAMKO's Technical Services Department for more information)
- A self-adhesive underlayment designed for use with asphalt shingles which meets ASTM D1970

For Asphalt Saturated Felt Underlayments

Apply the felt when the deck is dry. On roof decks with slopes 4" per foot and greater apply the felt parallel to the eaves lapping each course of the felt over the lower course at least 2". Where ends join, lap the felt 4". If left exposed, the felt may be adversely affected by moisture and weathering. Laying of the felt and the shingle application must be done together.

For All Other Specialty Underlayments

On roof decks with slopes 4" per foot and greater, apply the underlayment parallel to the eaves in accordance with underlayment application written instructions. The underlayment should not be left exposed for a longer period of time than is specified in the underlayment application written instructions. The final roof covering must be installed before the structure is exposed to adverse weather conditions, such as wind driven rain, high wind, hail, ice storms, etc.

In areas where ice builds up along the eaves or a back-up of water from frozen or clogged gutters is a potential problem, TAMKO® Moisture Guard®, TW Metal and Tile Underlayment or TW Underlayment (or any specialty eaves flashing product) may be applied to eaves, rakes, ridges, valleys, around chimneys, skylights or dormers to help prevent water damage. Contact TAMKO's Technical Services Department for more information.

5. APPLICATION INSTRUCTIONS

STARTER COURSE: A starter course may consist of TAMKO® Shingle Starter, TAMKO® 10-inch Starter, TAMKO® Perforated Starter, or self-sealing 3-tab shingles. If self-sealing 3-tab shingles are used, remove the exposed tab portion and install with the factory applied adhesive adjacent to the eaves. Attach the starter course with approved fasteners along a line parallel to and 1-1/2" to 3" above the eaves edge. The starter course should overhang the eave edge 1/4" to 3/4" and the rake edge 3/8" to 3/4" if drip edge flashing is not used along the eaves or rakes. If drip edge flashing is present, install shingles even with the drip edge or overhang the starter course over the drip edge up to 3/4". Minimizing overhang at eaves and rakes is recommended to improve wind resistance of the installed system.

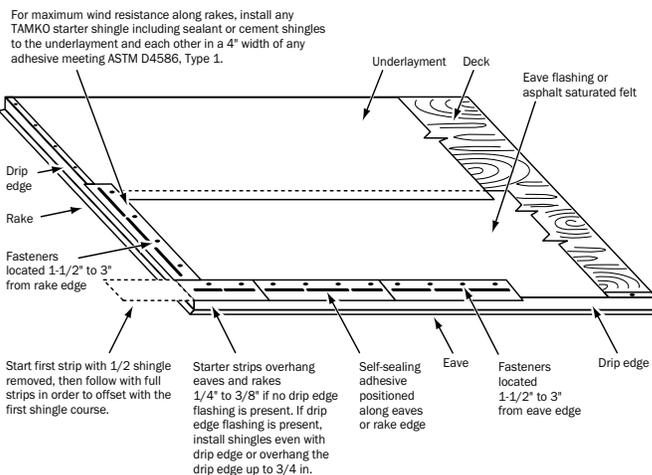

2 CUTS, 5 COURSES, NO-WASTE SHINGLE APPLICATION: Start the first course with a full-size shingle placed directly over the starter course. Cut 10-3/8" from a full shingle to form a shingle 29" long. Use this to start the second course (see diagram below). Cut a 23" long shingle to start the third course. Use the remaining 16-3/8" piece of shingle to start the fourth course and use the remaining 10-3/8" piece to begin the fifth course. Continue up the rake in as many rows as necessary using the same formula as outlined below.

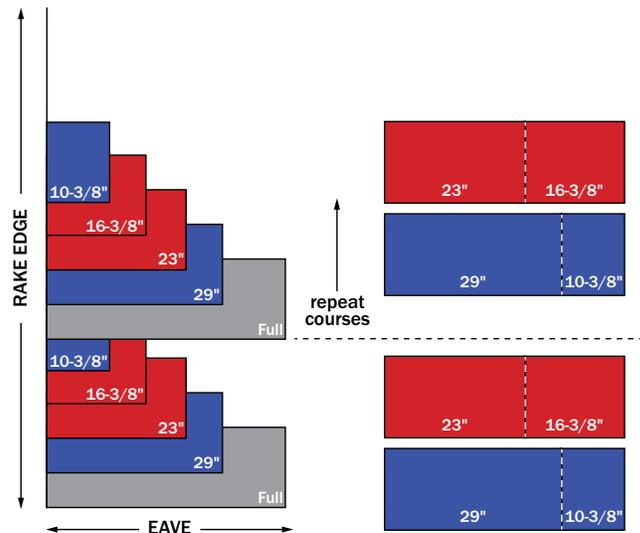

HERITAGE® ARCHITECTURAL ASPHALT SHINGLES

DALLAS, TX • FREDERICK, MD • JOPLIN, MO • PHILLIPSBURG, KS • TUSCALOOSA, AL



5. APPLICATION INSTRUCTIONS (continued)

The butt of the shingle should be aligned with the top edge of the sawtooth of the underlying shingle for a 5-5/8" exposure. When you make your final cut at the roof's edge, flip any pieces that are 8" or longer back onto the roof. These pieces can be worked in anywhere without creating zippers or color variations.

1. Cut your first course shingle to make 29" and a 10-3/8" length.
Cut a second shingle to make a 23" and a 16-3/8" length.

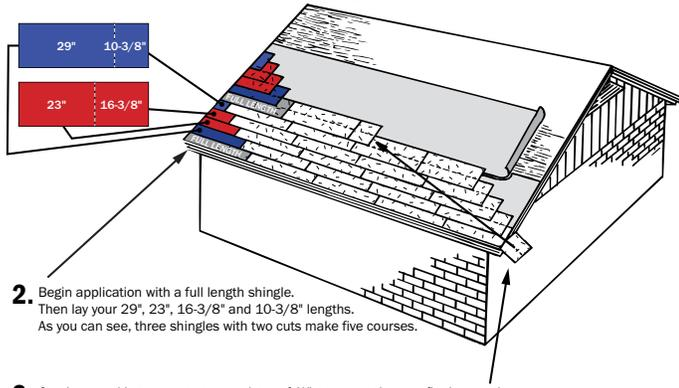

2. Begin application with a full length shingle.
Then lay your 29", 23", 16-3/8" and 10-3/8" lengths.
As you can see, three shingles with two cuts make five courses.
3. Continue working your way across the roof. When you make your final cut at the roof's edge, flip any pieces that are 8" or longer back onto the roof. These pieces can be worked in anywhere without creating zippers or color variations.

NOTE: do not align joints of shingle courses when working in cut pieces.
Joints should be no closer than 4" from one another.

6. LOW SLOPE APPLICATION

On slopes 2" per foot up to but less than 4" per foot (2:12 up to but less than 4:12) cover the deck with two layers of underlayment. Begin by applying the underlayment in a 1/2-sheet width plus 1/2 width of the side lap (i.e. for 36" wide asphalt saturated felt with a 2" side lap, the width would be 19") along the eaves. Place a full sheet width over the starter piece, completely overlapping it. All succeeding courses will be positioned to overlap the preceding course by 1/2-width sheet plus 1/2 width of the side lap. If winter temperatures average 25 °F or less, thoroughly cement the laps of the entire underlayment to each other with any adhesive meeting ASTM D4586 Type I from eaves and rakes to a point of at least 24" inside the interior wall line of the building. As an alternative, one layer of TAMKO® Moisture Guard®, TW Metal and Tile Underlayment, or TW Underlayment self-adhering underlayment may be used in lieu of the double coverage underlayment.

7. MANSARD ROOF OR STEEP SLOPE ROOF

If the slope is equal to or exceeds 21" per foot (60°), each shingle must be sealed with any adhesive meeting ASTM D4586 Type I immediately upon installation. Quarter-sized dabs of cement must be applied to shingles. Use 6 fasteners per shingle — see Section 3 for the Mansard Roof or Steep Slope Fastening Pattern.

8. RE-COVERING

High Wind Warranty is offered on new construction or complete tear-off applications only. It is not offered for re-cover applications.

Before re-covering a roof be certain to inspect the roof decks. All decking shall meet the requirements listed in Section 1.

It is not recommended to install laminated asphalt shingles directly over existing laminated shingles due to the unevenness of the existing multi-layered shingles. The performance of the sealant feature may be compromised, preventing the shingles from sealing properly. It is acceptable to install laminated shingles over existing three-tab strip shingles which are flat and essentially intact. Nail down or remove curled or broken shingles from the existing roof. Replace all missing shingles with new ones to provide a smooth base. Shingles that are buckled usually indicate warped decking or protruding nails. Hammer down all protruding nails or remove them and refasten in a new location. Remove all drip edge metal and replace with new.

If re-covering over an existing roof where new flashing is required to protect against ice dams (freeze/thaw cycle of water and/or the backup of water in frozen or clogged gutters), remove the old roofing to a point at least 24" beyond the interior wall line and apply TAMKO® Moisture Guard®, TW Metal and Tile Underlayment, or TW Underlayment. For more information contact TAMKO's Technical Services Department at 800-641-4691.

Measurements will vary when nesting over an existing 5" exposure shingled roof. Call TAMKO's Technical Services for further information.

The nesting procedure described below is the preferred method for re-covering over existing metric size shingles with a 5-5/8" exposure. See description below:

Starter Course: Remove the tabs and an additional portion from the head of a full-size shingle so that its height is equal to the exposure of the existing shingles. Position the resulting strip over the existing roof edge (with the factory-applied adhesive strip along the eaves). Cut approximately 6" from the rake end and apply the remaining portion at the eaves. Continue the starter strip by applying full length shingle strips cut to height as above, evenly along the existing roof at the eaves. The existing roof should overhang the eaves far enough to carry water off into the gutter. If this is not the case, cut and apply the starter strip so that it will provide sufficient overhang for proper drainage.

First Course: Remove an amount from the butt edge of a full-size shingle so that the remaining portion of the shingle fits between the butts of the existing third course. This course must also be applied evenly along the eaves edge of the new starter strip.

Second and Succeeding Courses: Remove 10-3/8" from the rake end of the first shingle in the second course, and continue with full width shingles for the remainder of the course, placing the top edge of each new shingle against the butt edge of the old shingle in the course above. This method should create an exposure of 5-5/8" after the first course. When beginning the succeeding courses continue to follow the application instructions. (See section 5).

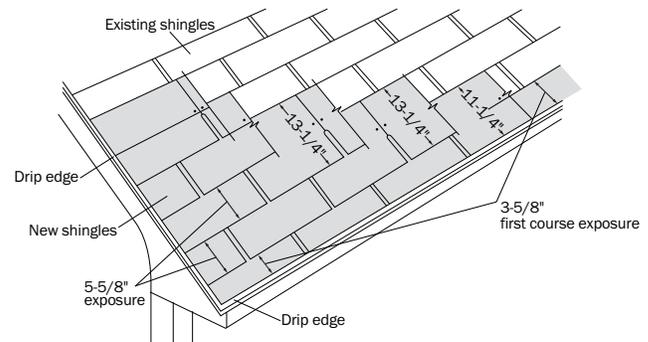

HERITAGE® ARCHITECTURAL ASPHALT SHINGLES

DALLAS, TX • FREDERICK, MD • JOPLIN, MO • PHILLIPSBURG, KS • TUSCALOOSA, AL



9. VALLEY APPLICATION

Center a minimum 36" wide sheet of TAMKO® Moisture Guard®, TW Metal and Tile Underlayment, any self-adhesive underlayment designed for use with asphalt shingles which meets ASTM D1970, or a minimum 50 lb. roll roofing in the valley. Nail the underlayment only where necessary to hold it in place and then only nail the outside edges. Install shingle underlayment and extend over valley flashing by 6".

IMPORTANT: PRIOR TO INSTALLATION, WARM SHINGLES TO PREVENT DAMAGE WHICH CAN OCCUR WHILE BENDING SHINGLES TO FORM VALLEY.

- The first course and only the first course of shingles from the intersecting roof surface should be woven with the first course of shingles on the starting roof.
- Apply the first course of shingles along the eaves on one of the intersecting roof planes and across the valley.

Note: For proper flow of water over the trimmed shingle, always start applying the shingles on the roof plane that has the lower slope or less height.

- Extend the end shingle at least 12" onto the adjoining roof. Apply succeeding courses in the same manner, extending them across the valley and onto the adjoining roof.
- Press the shingles tightly into the valley.
- Use normal shingle fastening methods.

Note: No fastener should be within 6" of the valley centerline, and two fasteners should be placed at the end of each shingle crossing the valley.

- To the adjoining roof plane, apply one row of shingles vertically facing the valley and 2" back from the valley centerline.

Note: For a neater installation, snap a chalkline over the shingles for guidance.

- To complete the valley, apply shingles on the adjoining roof plane by positioning the tip of the first shingle of each row at the 2" point from the centerline where the edge of the vertical shingle has been applied, covering the vertical shingle.

For alternate valley application methods, please contact TAMKO's Technical Services Department at 800-641-4691.

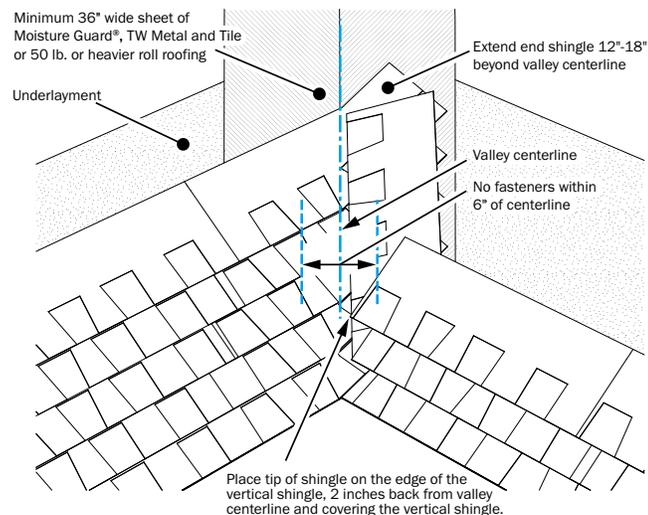

10. HIP AND RIDGE FASTENING DETAIL

TAMKO recommends the use of TAMKO® Hip and Ridge shingle products. Where matching colors are available, it is acceptable to use TAMKO® Elite Glass-Seal® shingles cut down to 12" pieces.

IMPORTANT: PRIOR TO INSTALLATION, CARE NEEDS TO BE TAKEN TO PREVENT DAMAGE WHICH CAN OCCUR WHILE BENDING SHINGLES IN COLD WEATHER.

Apply shingles up to a hip or ridge from both sides of the roof before finishing the intersection. To facilitate finishing, adjust the last few courses so that the ridge capping will adequately cover the top courses of shingles equally on both sides of the ridge.

To apply the capping, bend each shingle along the centerline so that it will extend an equal distance on each side of the hip or ridge. Chalk lines may assist in proper alignment. In cold weather, warm the shingle until it is pliable before bending.

Apply the shingles with a 5-1/8" exposure, beginning at the bottom of the hip or from the end of the ridge opposite the direction of the prevailing winds. See Figure 1. Secure each shingle as illustrated in Figure 2 with one fastener on each side, 5-5/8" back from the exposed end and 1" up from the edge. DO NOT NAIL BELOW THIS LINE 1" UP FROM THE EDGE. The length of the fastener should be long enough to penetrate through the roofing material and 3/4" into the wood decking or completely through the decking.

In high wind areas, it may be advisable, at the discretion of the roofing contractor, to use a spot of sealant to minimize blow off problems.

Alternatively, a 2-layer application of TAMKO® hip and ridge shingles with dimension 12-1/4" x 12" may be applied to all Heritage® roofs to enhance the overall appearance. When the second layer is applied, offset this layer by 1/4" to create a "shadow" effect. See Figure 3.

For a high profile appearance, TAMKO recommends Heritage® Designer Ridge. The application instructions are available at tamko.com or by calling TAMKO's Technical Services Department at 800-641-4691.

Figure 1

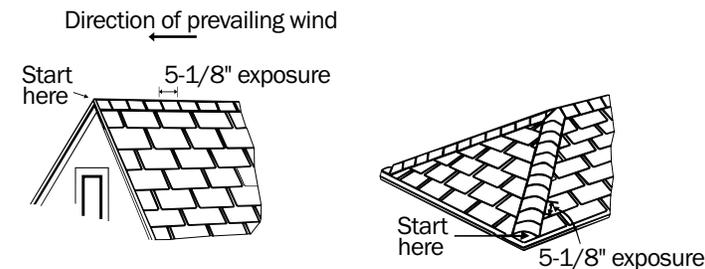

Figure 2

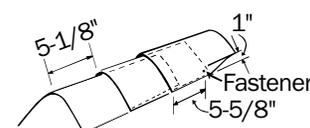

Figure 3

